



# LADDER SAFETY TRAINING

PFW ANNUAL TRAINING



# TRAINING OBJECTIVES

- The following will be discussed in this training:
  - General construction of ladders
  - Different types of ladders
  - How to select a ladder for a specific area
  - How to properly set up a ladder
  - How to identify equipment damage and proper ladder functionality
  - Proper ladder storage and maintenance
  - Safe ladder setup locations on a worksite

# OVERVIEW

- Ladders are tools commonly used to gain access to higher levels that are otherwise unreachable.
- When maintained properly and used according to safety guidelines, they are a simple and effective tool.
- However, each year thousands of workers are either injured or killed in ladder related accidents.
- As a result, there are established safety guidelines for working with ladders in an attempt to prevent ladder related accidents.



# GENERAL LADDER CONSTRUCTION

- Ladders can be constructed from a variety of materials including wood, metals, and reinforced plastics.
  - They generally consist of two side rails and are joined at regular intervals by cross pieces called “steps” or “rungs”
- In general, ladders have very few working parts.
  - However, extension ladders usually have pulleys, ropes, and ladder locks
- In some cases, ladders may be equipped with roof hooks or adjustable feet to provide added stabilization



# TYPES OF LADDERS

- Ladders come in a wide variety of types designed for various jobs and will generally fit into one of four categories
  - Step ladder
  - Straight ladder
  - Extension ladder
  - Fixed ladder

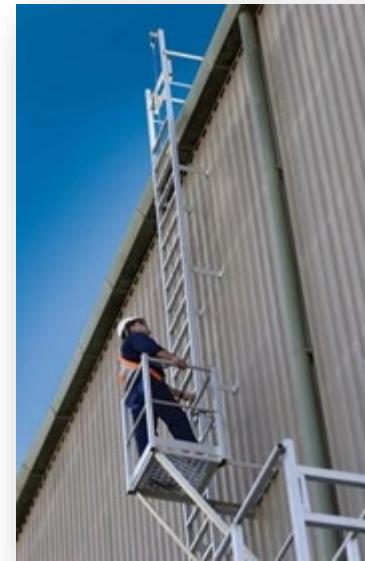

# TYPES OF LADDERS

- Step ladders are self-supporting portable ladders that are non-adjustable in length
  - They are commonly used in areas where items need to be reached but there is not an accessible structure to provide ladder support

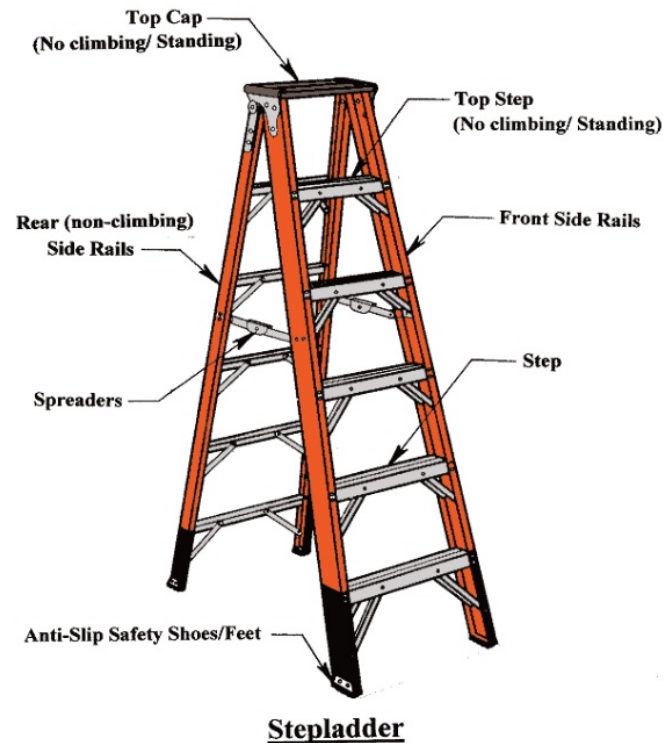

# TYPES OF LADDERS

- Straight ladders are portable ladders that are NOT self-supporting
  - They are made of a single section that is not adjustable in length
  - They are used to reach items on a structure that is providing the support for the ladder

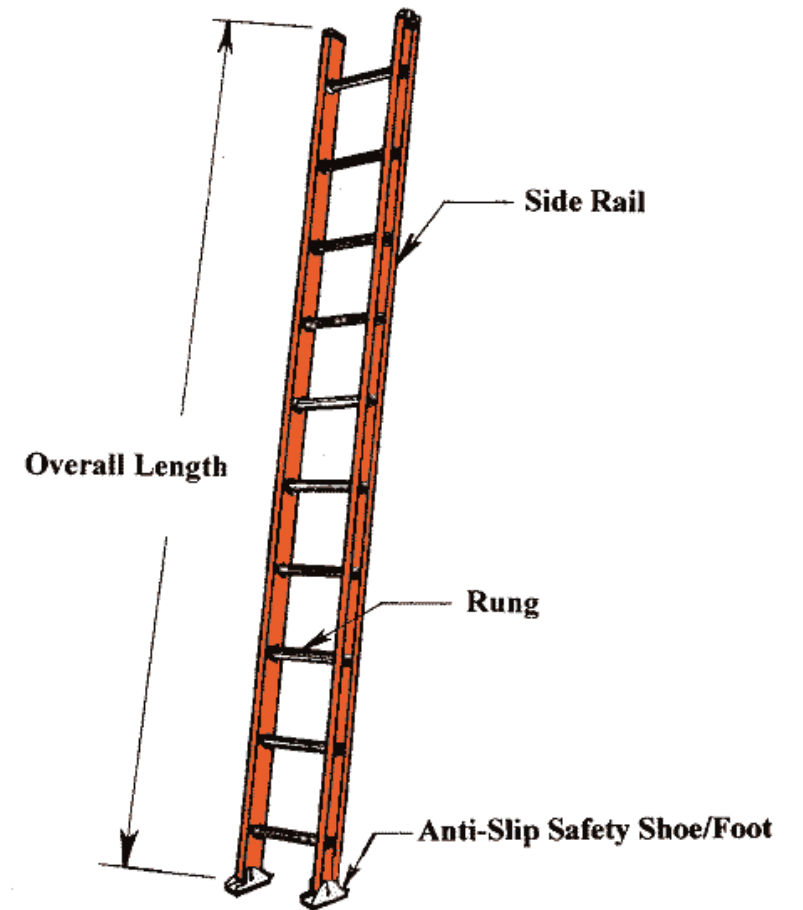

# TYPES OF LADDERS

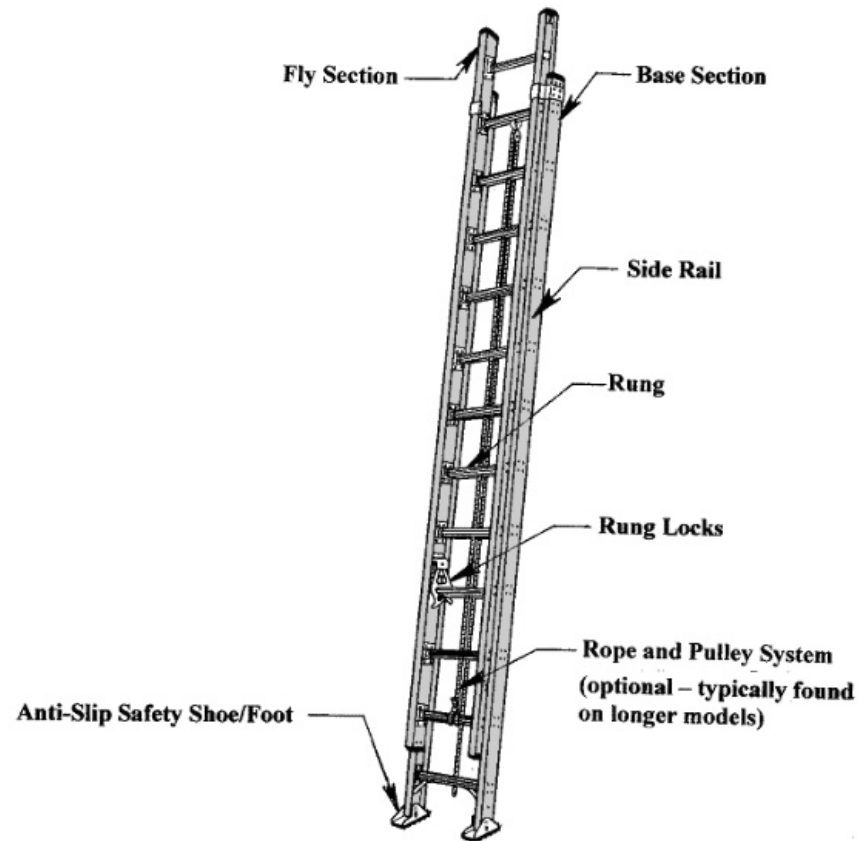

**Extension Ladder**

- Extension ladders are portable, NON self-supporting, and consist of two or more sections that are adjustable in length
- Extension ladders are used like straight ladders, but allow for greater heights to be reached



# TYPES OF LADDERS

- Fixed ladders are straight ladders that are permanently fixed to a structure or piece of equipment
  - These ladders may have additional structures attached including rest platforms, cages, or wells



# HOW TO SELECT A LADDER

- Selecting the appropriate ladder for the job can greatly reduce the chance of a ladder related accident
- When selecting a ladder, considerations must include
  - Height and pitch requirements
  - Weight capacity
  - Surface conditions
  - Hazardous obstructions

# PROPER SET UP

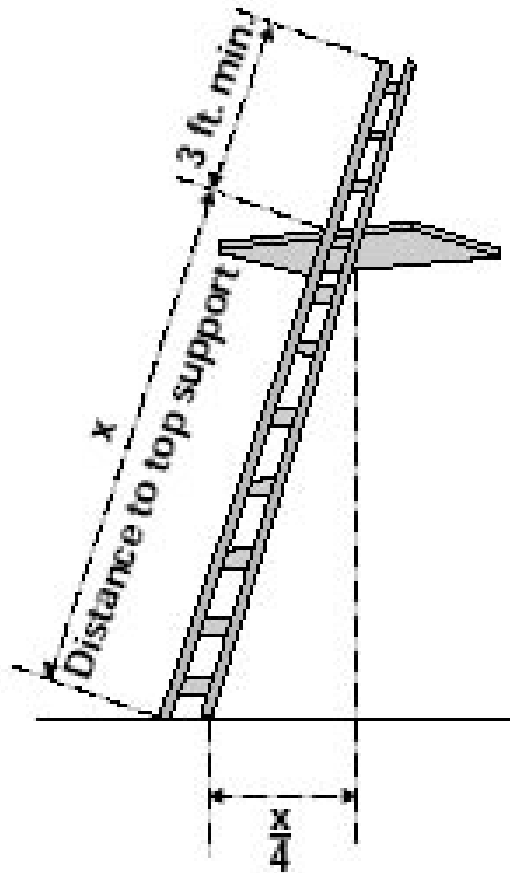

- When the purpose of a straight or extension ladder is to access an elevated landing, then selecting a ladder of the precise height is one of the key factors in working safely
- The correct height of a ladder will be dictated by setting it up at the correct pitch
- It is required that a ladder's height extend a minimum of 3 feet beyond the upper support of the ladder

# PROPER SET UP

- When using an extension ladders, the integrity of the ladders strength is based on whether the ladder is used “fly out” or “fly in”
  - “Fly out” means the extensible sections are place *AWAY* from the structure that is being ascended
  - “Fly in” means the sections are placed *TOWARD* the structure
- Always confirm with the manufacturers instructions on correct ladder placement

# PROPER SET UP

- Sections of extension ladders must overlap adjacent sections according to the following

<b>Length of Ladder</b>	<b>Overlap</b>
Under 36'	3 feet
Over 36' and under 48'	4 feet
Over 48' and under 60'	5 feet

# PROPER SET UP

- An approximation of correct ladder pitch can be achieved by
  - 1) start by leaning the ladder against the elevated landing or upper part of the structure you are going to ascend
  - 2) with the top of the ladder leaning beyond the structures upper support pull the base of the ladder out so that the pitch is roughly 75°
  - 3) stand so you touch the bottom side rails of the toe of each shoe, stand straight and reach your arms directly forward
    - The palms of your hands should be touching the rungs level to the top of your shoulders if the pitch is correct

# PROPER SET UP

- Another way to approximate the pitch of a ladder is to divide the height of the structure being ascended by 4
  - $\frac{1}{4}$  of the structures height is the distance the ladders base should be positioned from the base of the structure
  - For example, if a building is 16 feet high, then  $\frac{1}{4}$  of that is 4 feet

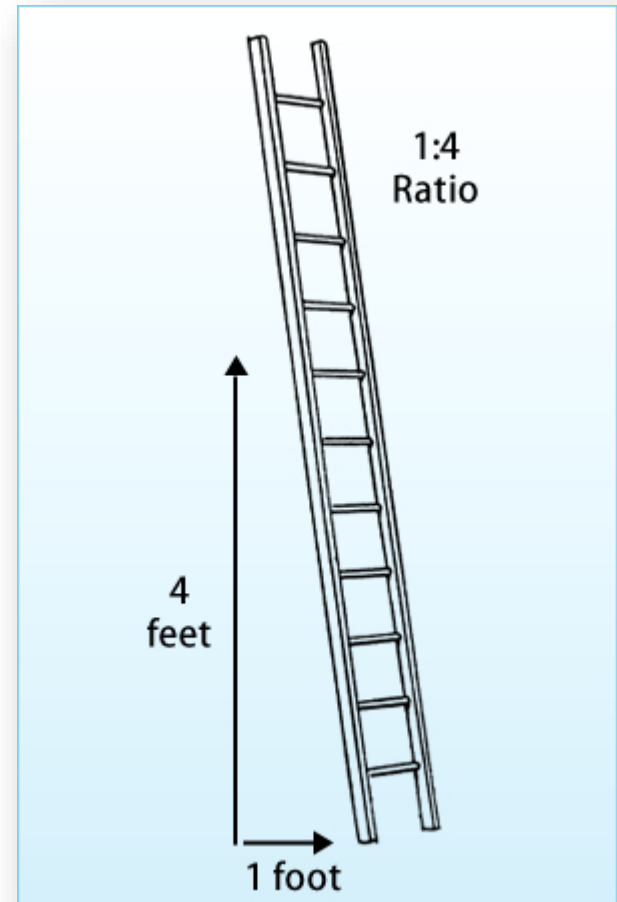

## PROPER SET UP

- Once the ladders pitch has been established, extend or retract the upper part of an the extension ladder to no less than 3 feet above the upper support of the ladder
  - If using a straight ladder, determine whether the ladders length can accommodate the 3 feet above the upper support, **If it can't then choose a more suitable ladder length**



# LADDER CAPACITY

- The ladders weight capacity is another key factor to consider when choosing a ladder
  - Ladders can suddenly give way and break under excessive weight stress
- When evaluating the stress to be placed on a ladder, remember to factor in the weight of the person climbing the ladder and any additional equipment including PPE and tool belts
  - If tool belts or equipment caused the weight capacity to be exceeded, use an alternative means of transporting them such as a tow-line

# LADDER CAPACITY

- Portable ladders are constructed under general classes, referred to as the “duty rating”

Type	Rating
Type IAA	Extra heavy duty.....375 lbs
Type IA	Heavy duty.....300 lbs
Type I	Heavy duty.....250 lbs
Type II	Medium duty.....225 lbs
Type II	Light duty.....200 lbs



# WORK AREA

- Observing the surface condition where the ladder will be set up is an additional component to selecting the appropriate ladder for the job.
  - When a surface is uneven, use a ladder that is equipped with proper attachments designed to level the feet of the ladder
  - If the surface is hard or smooth, choose a ladder with non-skid feet and take extra precautions to secure the base
  - NEVER use unstable materials to level a ladder



**WRONG**

# WORK AREA

- When selecting a ladder, thoroughly inspect your job site for hazards
  - Ex. Exposed electrical equipment or power lines – a non-conductive ladder would be best and maintain 10 feet of clearance from the hazard

# INSPECTION

- If you suspect that a structure may not be stable enough to support a leaning straight ladder, then chose a self-supporting step ladder instead
- NEVER use a step ladder as a straight ladder by leaning it against a structure
  - Step ladders are NOT designed to function in this manner



**WRONG**

# INSPECTION



- Once you have selected the correct ladder for the job, it is important to conduct a visual and operational inspection before working with it
  - It is your responsibility to make sure the ladder is fit for use before each job

# INSPECTION

- Ask yourself the following questions when inspecting a ladder
  - Are the rungs or steps secured and free of oil, grease, and dirt?
  - Is all the hardware secured and functioning correctly?
  - If ropes are attached, are they in good condition?
  - Are the support braces intact?
  - Are there any signs of structural damage?
- If the ladder does not pass your inspection, remove the ladder from service and tag it for maintenance to avoid the accidental use by co-workers
- If a ladder is damaged beyond repair, be sure to properly dispose of it

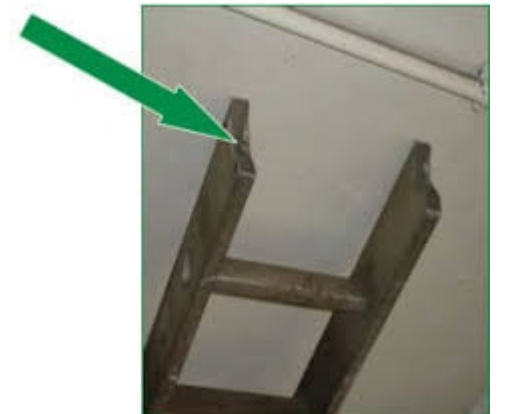



# TRANSPORT

- While transferring your ladder to the job site, carry the ladder so that it is parallel to the ground and balance the weight by holding the side rail with your palm facing inward and at the middle of the ladder
- For ladders exceeding 20 feet, always have two people carry the ladder
- If a ladder is transported on a vehicle, make sure it is properly secured at both ends

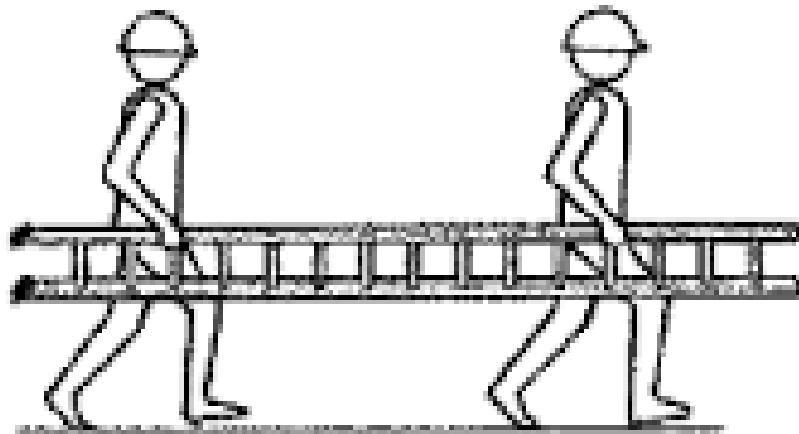

# TIE OFF

- When working with a ladder longer than 25 feet, secure the ladder by bracing all 4 points or tying off at the top and bottom
- For shorter ladders, having a co-worker hold the ladder in place can provide extra support

# WARN OTHERS

- If you are planning to use a ladder in a high traffic area, on blind corners, or in front of doorways, take proper precautions to seal off the area
  - Lock or brace the doors, post warning signs to prevent accidental collision

# PRECAUTIONS

- Because falls from ladders are a major source of fatalities and disabling injuries, it is very important to remember the following rules when using ladder to access your work area
  - Always face the ladder when climbing up or down
  - Never climb the supportive cross bracing on the back of a step ladder
  - Never use the top two rungs on step ladders
  - Never use the top three rungs on straight or extension ladders
  - Never use a ladder for a purpose for which it was not designed
  - Never attempt to reposition a ladder while in use
  - Do not reach beyond your arm's normal extension
  - Never allow more than one person on a ladder at a time
  - Never attempt to strap or tie two ladders together
  - Always keep three points of contact on the ladder



# STORAGE

- Proper ladder care and storage is important to the structural integrity of the ladder
  - Make sure that ladders are stored in areas that are clean, dry, and non-corrosive
  - Use racks or brackets that can provide ample weight support to prevent ladders from becoming damaged



# QUESTIONS?

- EHS contact information:
  - Stephanie Phillips: 260-481-4193 [steels@ipfw.edu](mailto:steels@ipfw.edu)
  - Erin Turner: 260-481-4197 [mckien01@ipfw.edu](mailto:mckien01@ipfw.edu)

**PURDUE UNIVERSITY®**  
**FORT WAYNE**

**Environmental Health  
and Safety**